

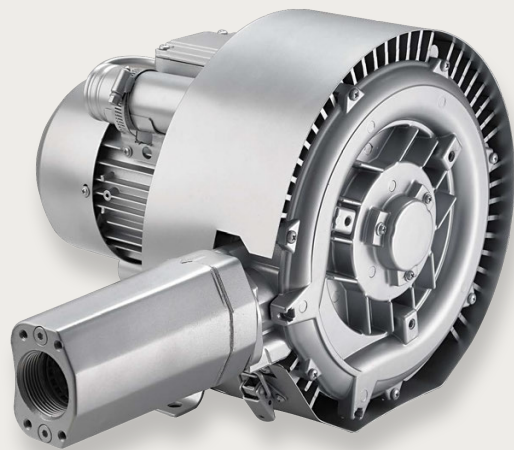

Side channel blower 320 series

The standard VACOM® design, with housing an impeller made of aluminum alloy, is a direct drive configuration, with a dynamically balanced impeller, fitted directly on the motor shaft. The impeller rotates inside of the stator housing with a very small clearance. The absence of lubricants guarantees a 100% oil free vacuum or compression. Construction features of the VACOM® side channel blower are the very reliable operation and low maintenance. VACOM® blowers are directly driven, impellers fixed directly on the drive shaft. Impeller bearing is installed in the front cover and easily to assemble and disassemble. Machines are small and lightweight. VACOM® blowers are already available with differential pressures up to 700 mbar and capacities of 2000 m³/ hr.



Features

- ♦ Available from stock
- ♦ Almost free of maintenance
- ♦ Low power consumption
- ♦ Oil free compression, no oil in the medium
- ♦ Made of aluminum, so low weight and high corrosion resistance.

Accessories

- ♦ Suction filter TGF (for vacuum)
- ♦ Suction filter VCFT (for compression)
- ♦ Pressure relief valve DB
- ♦ External silencer EGD
- ♦ Fittings
- ♦ Various: change valve, pressure gauge, non return valve



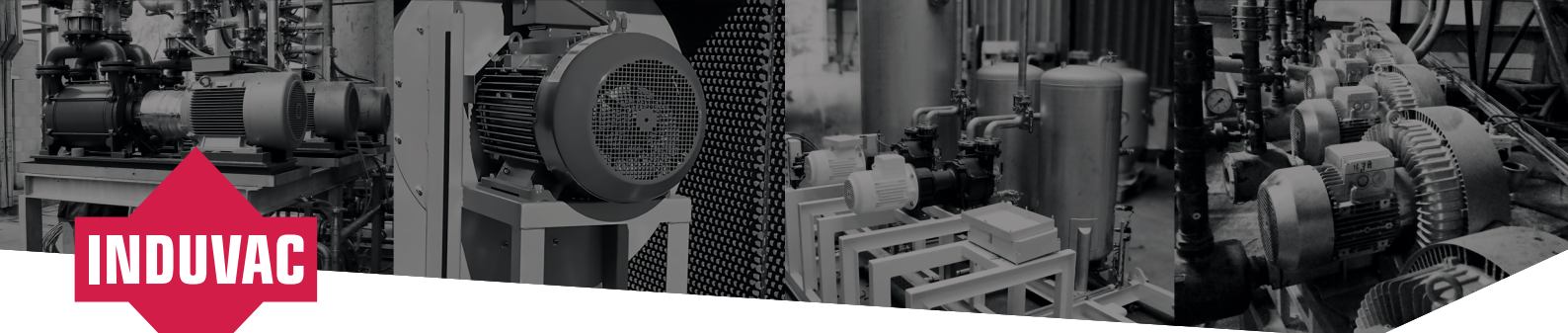

Technical data

Type No.	Curve No.	Freq. Hz	Power kW	Voltage V		Current A		Capacity m ³ /hr	Pressure difference mbar		Sound level dB(A)	Connec-tion "G	Weight kg
				Δ	Y	Δ	Y		Vacuum	Pressure			
VC 311-320	32A	50	1,30	220-240	380-420	4,70	2,70	110	-260	290	58	1,25	18
	32B	60	1,50	265-290	460-520	4,60	2,65	130	-280	320	60	1,25	18
		50	1,10	230	400	4,00	2,31						
		60	1,30	480		2,34							
VC 111-320	32C	50	1,10	230		7,30		120	-240	280	58	1,25	17
	32D	60	1,30	230		8,30		145	-230	260	60	1,25	17

Curves

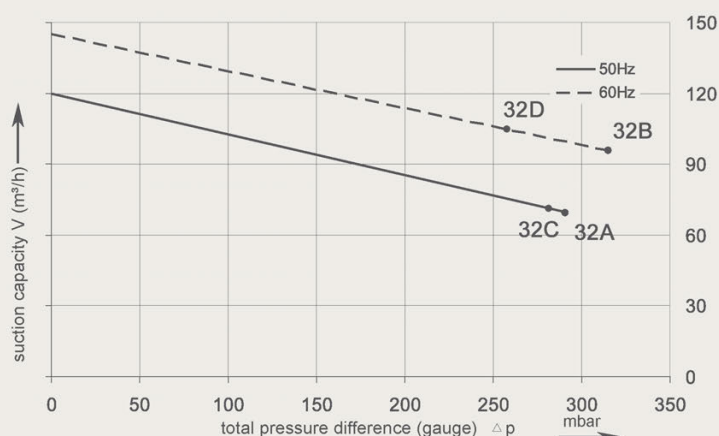
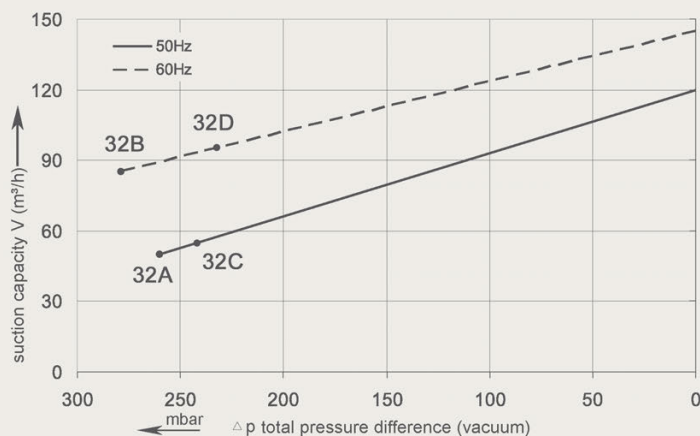

Curves are valid for dry air, with a temperature of 15°C at the inlet and a pressure of 1013 mbar(a) at the inlet or outlet connection (for over- or under-pressure application respectively). The tolerance on capacity is +/- 10%. No rights can be derived from the sketches, dimensions and contents of this data sheet. The data is for information purposes only. Induvac reserves the right to change or modify the data. No complaints can be made about this.

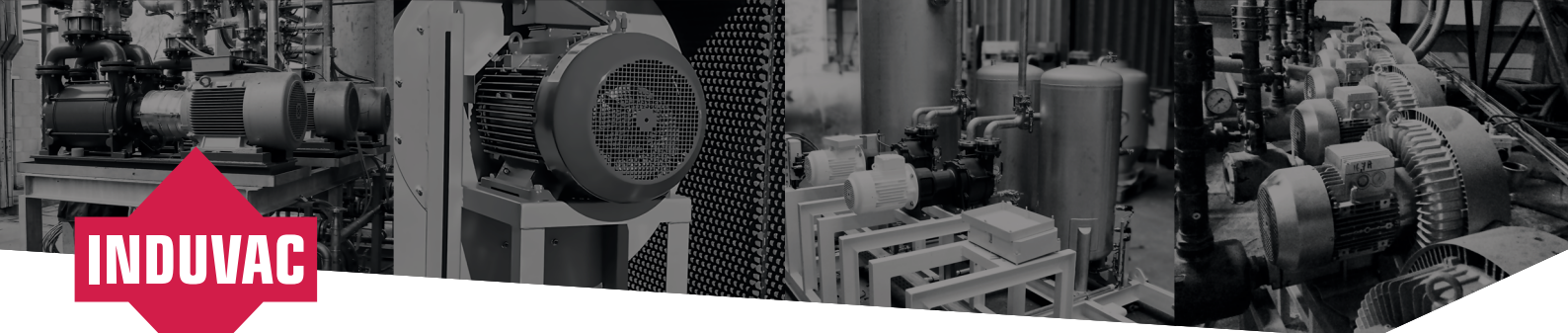

Dimensions

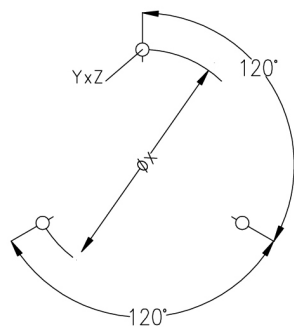
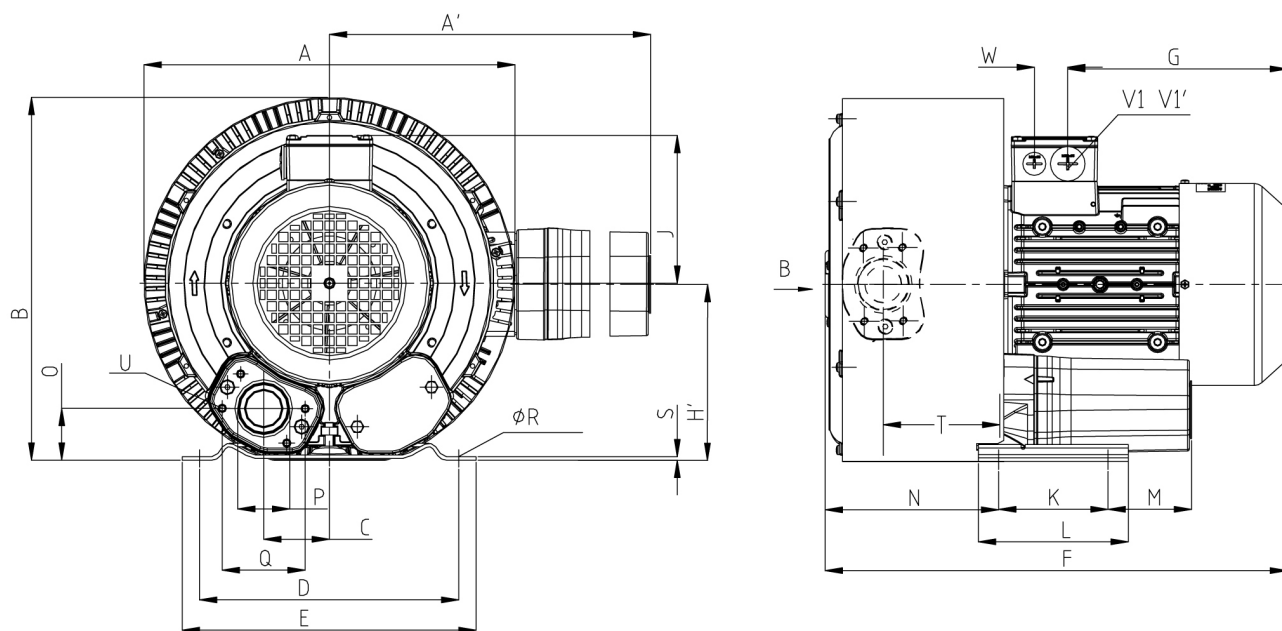

Curve No.	Type	A	A'	B	C	D	E	F	G	H	H'	J	K	L	M
32A / 32B	VC 311-320	293	324	286	47	225	230	354	160	141	114	120	83	108	82
32C / 32D	VC 111-320	322	324	286	47	225	230	354	160	141	114	120	83	108	82
Curve No.	Type	N	O	P	Q	ØR	S	T	U	V1	V'1	ØX	YxZ	X-holes	
32A / 32B	VC 311-320	138	41	G 1 1/4"	64	10	2.5	92	M6 X 17	M25 X 1.5	M16 X 1.5	160	M6 X 15	51°/171°/291°	
32C / 32D	VC 111-320	138	41	G 1 1/4"	64	10	2.5	92	M6 X 19	M25 X 1.5	M16 X 1.5	160	M6 X 15	51°/171°/291°	