



Axiaal buisventilator HGT en HGTX serie

Buisvormige axiaalventilatoren uitgerust met 6 of 9 blads aluminium waaiers met verschillende hellingshoeken, direct of indirect aangedreven.

Ventilator:

- Luchtrichting motor-waaier.
- 6 of 9 blads gegoten aluminium waaier met instelbare hellingshoek.
- Behuizing van plaatstaal.
- Standaard uitvoering in lange omkasting, voorzien van inspectieluik.

Motor:

- Motoren met IE3-efficiëntie voor vermogens gelijk aan of groter dan 0,75 kW, uitgezonderd enkelfasig, 2-snelheden en 8-polig.
- Klasse F motoren met kogellagers en IP55 bescherming.
- Driefasig 230 / 400 V 50 Hz (tot 4 kW) en 400 / 690 V 50 Hz (vermogens groter dan 4 kW).
- Werktemperatuur: -25 °C +120 °C.

Afwerking:

- Anticorrosief in polyesterhars gepolymeriseerd bij 190 °C, na ontvetting met fosfaatvrije nanotechnologische behandeling.

Op aanvraag:

- Waaiermotor luchtrichting.
 - 100% omkeerbare waaiers.
- Speciale wikkelingen voor verschillende spanningen.
- ATEX Categorie 2 certificering.
- Motoren met 2 snelheden.
- De steunvoeten worden als accessoire geleverd.



Accessoires:



INT



VSD3/A-RFT
VSD1/A-RFM



ELECTRIC
CONTROL
PANELS

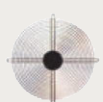

RT



PT/H



BTUB



BAC



PS



S



SI



PV

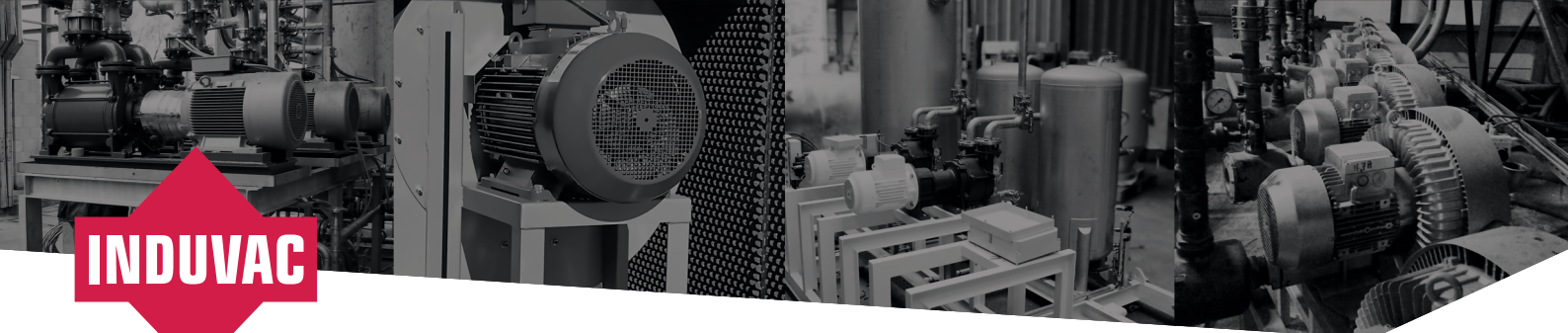

Technische gegevens:

Model			Toerental (r/min)	Maximaal toelaatbare stroom (A)			Geïnstalleerd vermogen (kW)	Maximale capaciteit (m ³ /h)	Geluids-druk dB(A)	Gewicht (circa) (kg)			Volgens to ErP
				230V	400V	690V				HGT Lang	HGT Kort	HGTX	
HGT	HGTX	125-4T/6-20 IE3	1465		27.90	16.20	15.00	78300	89	294	266	414	2015
HGT	HGTX	125-4T/6-25 IE3	1470		35.10	20.30	18.50	92000	90	372	329	459	2015
HGT	HGTX	125-4T/6-30 IE3	1470		41.00	23.80	22.00	98100	90	372	329	459	2015
HGT	HGTX	125-4T/6-40 IE3	1480		57.10	33.10	30.00	117000	92	477	433	566	2015
HGT	HGTX	125-4T/6-50 IE3	1480		69.20	40.10	37.00	123700	93	560	504	631	2015
HGT	HGTX	125-4T/6-60 IE3	1475		80.90	46.90	45.00	136000	94	598	542	669	2015
HGT	HGTX	125-4T/6-75 IE3	1480		98.60	57.20	55.00	148000	95	614	564	700	2015
HGT	HGTX	125-4T/6-100 IE3	1485		134.00	77.70	75.00	161000	96	708	658	794	2015
HGT	HGTX	125-4T/9-25 IE3	1470		35.10	20.30	18.50	79750	88	381	338	468	2015
HGT	HGTX	125-4T/9-30 IE3	1470		41.00	23.80	22.00	97000	89	381	338	468	2015
HGT	HGTX	125-4T/9-40 IE3	1480		57.10	33.10	30.00	111200	91	486	442	575	2015
HGT	HGTX	125-4T/9-50 IE3	1480		69.20	40.10	37.00	118350	93	569	513	640	2015
HGT	HGTX	125-4T/9-60 IE3	1475		80.90	46.90	45.00	127000	94	607	551	678	2015
HGT	HGTX	125-4T/9-75 IE3	1480		98.60	57.20	55.00	142000	95	623	573	709	2015
HGT	HGTX	125-4T/9-100 IE3	1485		134.00	77.70	75.00	155000	99	717	667	803	2015
HGT	HGTX	125-6T/6-5.5 IE3	960	15.60	8.99		4.00	51300	77	216	183	347	2015
HGT	HGTX	125-6T/6-7.5 IE3	970		11.20	6.49	5.50	60300	77	228	195	359	2015
HGT	HGTX	125-6T/6-10 IE3	975		14.80	8.58	7.50	72250	79	306	278	426	2015
HGT	HGTX	125-6T/6-15 IE3	975		21.90	12.70	11.00	85450	81	307	279	427	2015
HGT	HGTX	125-6T/6-20 IE3	975		28.20	16.30	15.00	92850	82	416	373	503	2015
HGT	HGTX	125-6T/6-25 IE3	980		35.90	20.80	18.50	103000	84	449	405	538	2015
HGT	HGTX	125-6T/9-10 IE3	975		14.80	8.58	7.50	68200	78	315	287	435	2015
HGT	HGTX	125-6T/9-15 IE3	975		21.90	12.70	11.00	77550	81	316	288	436	2015
HGT	HGTX	125-6T/9-20 IE3	975		28.20	16.30	15.00	92900	84	425	382	512	2015
HGT	HGTX	125-6T/9-25 IE3	980		35.90	20.80	18.50	98700	85	458	414	547	2015
HGT	HGTX	125-6T/9-30 IE3	980		42.40	24.60	22.00	104000	87	463	419	552	2015
HGT	HGTX	125-8T/6-3	705	9.53	5.50		2.20	45700	69	218	185	349	2015
HGT	HGTX	125-8T/6-4	705	12.82	7.40		3.00	51800	71	225	192	356	2015
HGT	HGTX	125-8T/6-5.5	710	16.11	9.30		4.00	61500	72	258	230	378	2015
HGT	HGTX	125-8T/6-7.5	710		12.00	7.20	5.50	67500	73	271	243	391	2015
HGT	HGTX	125-8T/6-10	725		16.00	9.50	7.50	75500	75	301	273	421	2015
HGT	HGTX	125-8T/9-4	705	12.82	7.40		3.00	48200	70	234	201	365	2015
HGT	HGTX	125-8T/9-5.5	710	16.11	9.30		4.00	55200	73	267	239	387	2015
HGT	HGTX	125-8T/9-7.5	710		12.00	7.20	5.50	67000	75	280	252	400	2015
HGT	HGTX	125-8T/9-10	725		16.00	9.50	7.50	74750	76	310	282	430	2015
HGT	HGTX	125-8T/9-15	720		24.00	13.80	11.00	80800	79	372	329	459	2015
HGT	-	140-6T/6-5.5 IE3	960	15.60	8.99		4.00	58000	82	266	229		2015
HGT	-	140-6T/6-7.5 IE3	970		11.20	6.49	5.50	66000	84	278	241		2015
HGT	-	140-6T/6-10 IE3	975		14.80	8.58	7.50	80700	85	365	326		2015
HGT	-	140-6T/6-15 IE3	975		21.90	12.70	11.00	96700	86	366	327		2015
HGT	-	140-6T/6-20 IE3	975		28.20	16.30	15.00	104000	87	472	423		2015
HGT	-	140-6T/6-25 IE3	980		35.90	20.80	18.50	115000	88	506	457		2015
HGT	-	140-6T/6-30 IE3	980		42.40	24.60	22.00	119000	89	511	462		2015
HGT	-	140-6T/9-10 IE3	975		14.80	8.58	7.50	70000	84	374	335		2015
HGT	-	140-6T/9-15 IE3	975		21.90	12.70	11.00	86000	86	375	336		2015

HGT -	140-6T/9-20 IE3	975		28.20	16.30	15.00	97500	87	482	432	2015
HGT -	140-6T/9-25 IE3	980		35.90	20.80	18.50	111000	88	515	467	2015
HGT -	140-6T/9-30 IE3	980		42.40	24.60	22.00	118500	89	520	472	2015
HGT -	140-6T/9-40 IE3	985		55.40	32.10	30.00	132000	91	676	614	2015
HGT -	140-6T/9-50 IE3	985		67.20	39.00	37.00	139000	92	693	638	2015
HGT -	140-8T/6-3	705	9.53	5.50		2.20	47500	78	268	231	2015
HGT -	140-8T/6-4	705	12.82	7.40		3.00	57600	79	275	238	2015
HGT -	140-8T/6-5.5	710	16.11	9.30		4.00	65200	80	317	278	2015
HGT -	140-8T/6-7.5	710		12.00	7.20	5.50	73300	81	330	291	2015
HGT -	140-8T/6-10	725		16.00	9.50	7.50	82200	82	360	321	2015
HGT -	140-8T/6-15	720		24.00	13.80	11.00	94200	83	419	370	2015
HGT -	140-8T/9-4	705	12.82	7.40		3.00	47200	79	284	247	2015
HGT -	140-8T/9-5.5	710	16.11	9.30		4.00	64400	79	326	287	2015
HGT -	140-8T/9-7.5	710		12.00	7.20	5.50	69200	81	339	300	2015
HGT -	140-8T/9-10	725		16.00	9.50	7.50	78700	82	369	330	2015
HGT -	140-8T/9-15	720		24.00	13.80	11.00	94300	83	429	379	2015
HGT -	140-8T/9-20	725		31.00	18.10	15.00	103000	86	485	437	2015
HGT -	160-6T/6-10 IE3	975		14.80	8.58	7.50	75000	83	439	385	2015
HGT -	160-6T/6-15 IE3	975		21.90	12.70	11.00	93500	85	440	386	2015
HGT -	160-6T/6-20 IE3	975		28.20	16.30	15.00	120500	86	559	490	2015
HGT -	160-6T/6-25 IE3	980		35.90	20.80	18.50	130000	87	593	524	2015
HGT -	160-6T/6-30 IE3	980		42.40	24.60	22.00	140000	88	598	529	2015
HGT -	160-6T/6-40 IE3	985		55.40	32.10	30.00	158000	89	771	672	2015
HGT -	160-6T/6-50 IE3	985		67.20	39.00	37.00	171000	91	784	699	2015
HGT -	160-6T/9-15 IE3	975		21.90	12.70	11.00	87000	85	450	396	2015
HGT -	160-6T/9-20 IE3	975		28.20	16.30	15.00	104000	86	569	500	2015
HGT -	160-6T/9-25 IE3	980		35.90	20.80	18.50	127000	87	603	534	2015
HGT -	160-6T/9-30 IE3	980		42.40	24.60	22.00	135000	88	608	539	2015
HGT -	160-6T/9-40 IE3	985		55.40	32.10	30.00	147000	89	781	682	2015
HGT -	160-6T/9-50 IE3	985		67.20	39.00	37.00	165000	90	794	710	2015
HGT -	160-6T/9-60 IE3	985		84.40	48.90	45.00	177000	91	1019	920	2015
HGT -	160-6T/9-75 IE3	985		103.00	59.70	55.00	193000	92	1077	978	2015
HGT -	160-6T/9-100 IE3	990		139.00	80.60	75.00	207500	93	1232	1133	2015
HGT -	160-8T/6-4	705	12.82	7.40		3.00	70900	76	344	292	2015
HGT -	160-8T/6-5.5	710	16.11	9.30		4.00	84500	77	391	337	2015
HGT -	160-8T/6-7.5	710		12.00	7.20	5.50	77000	79	404	350	2015
HGT -	160-8T/6-10	725		16.00	9.50	7.50	95000	80	434	380	2015
HGT -	160-8T/6-15	720		24.00	13.80	11.00	109000	82	506	437	2015
HGT -	160-8T/6-20	725		31.00	18.10	15.00	123000	83	563	494	2015
HGT -	160-8T/6-25	725		36.00	20.70	18.50	130000	84	641	542	2015
HGT -	160-8T/9-7.5	710		12.00	7.20	5.50	70000	79	414	360	2015
HGT -	160-8T/9-10	725		16.00	9.50	7.50	87000	80	444	390	2015
HGT -	160-8T/9-15	720		24.00	13.80	11.00	103000	82	516	447	2015
HGT -	160-8T/9-20	725		31.00	18.10	15.00	117000	83	573	504	2015
HGT -	160-8T/9-25	725		36.00	20.70	18.50	133000	84	651	552	2015
HGT -	160-8T/9-30	725		42.00	24.40	22.00	140000	85	666	567	2015
HGT -	160-8T/9-40	730		61.00	35.10	30.00	151000	86	724	640	2015

Aan de schetsen, maatvoering en de inhoud van dit datablad kunnen geen rechten worden ontleend. De gegevens zijn slechts informatief bedoeld. Induvac behoudt zich het recht voor om de gegevens te wijzigen of aan te passen. Hierover kan niet gereclameerd worden. De aangegeven geluidswaarden zijn bepaald door het meten van de geluidsdruk- en geluidsvermogensniveaus in dB(A), verkregen in het vrije veld bij een afstand gelijk aan tweemaal de grootte van de ventilator plus de waaierdiameter, met een minimum van 1,5 m. Geluidsvermogenspectrum Lw(A) in dB(A) frequentieband in [Hz].

Akoestische gegevens:

Sound power spectrum Lw(A) in dB(A) per Hz frequency band

Model	63	125	250	500	1000	2000	4000	8000	Model	63	125	250	500	1000	2000	4000	8000
125-4T/6-20	66	74	90	97	99	94	88	84	140-6T/9-25	70	88	97	96	95	91	82	77
125-4T/6-25	67	75	91	98	100	95	89	85	140-6T/9-30	70	88	97	96	95	91	82	77
125-4T/6-30	68	76	92	99	101	96	90	86	140-6T/9-40	71	89	98	97	96	92	83	78
125-4T/6-40	69	77	93	100	102	97	91	87	140-6T/9-50	74	92	101	100	99	95	86	81
125-4T/6-50	71	79	95	102	104	99	93	89	140-8T/6-3	61	73	82	86	84	78	68	65
125-4T/6-60	72	80	96	103	105	100	94	90	140-8T/6-4	63	75	84	88	86	80	70	67
125-4T/6-75	72	80	96	103	105	100	94	90	140-8T/6-5.5	64	76	85	89	87	81	71	68
125-4T/6-100	74	82	98	105	107	102	96	92	140-8T/6-7.5	65	77	86	90	88	82	72	69
125-4T/9-25	66	74	91	97	98	93	88	84	140-8T/6-10	66	78	87	91	89	83	73	70
125-4T/9-30	67	75	92	98	99	94	89	85	140-8T/6-15	68	80	89	93	91	85	75	72
125-4T/9-40	68	76	93	99	100	95	90	86	140-8T/9-4	61	72	83	88	86	82	72	67
125-4T/9-50	70	78	95	101	102	97	92	88	140-8T/9-5.5	62	73	84	89	87	83	73	68
125-4T/9-60	72	80	97	103	104	99	94	90	140-8T/9-7.5	63	74	85	90	88	84	74	69
125-4T/9-75	72	80	97	103	104	99	94	90	140-8T/9-10	64	75	86	91	89	85	75	70
125-4T/9-100	74	82	99	105	106	101	96	92	140-8T/9-15	65	76	87	92	90	86	76	71
125-6T/6-5.5	59	68	81	84	85	82	71	67	140-8T/9-20	67	78	89	94	92	88	78	73
125-6T/6-7.5	60	69	82	85	86	83	72	68	160-6T/6-10	67	82	91	93	90	84	76	72
125-6T/6-10	61	70	83	86	87	84	73	69	160-6T/6-15	68	83	92	94	91	85	77	73
125-6T/6-15	63	72	85	88	89	86	75	71	160-6T/6-20	70	85	94	96	93	87	79	75
125-6T/6-20	65	74	87	90	91	88	77	73	160-6T/6-25	71	86	95	97	94	88	80	76
125-6T/6-25	66	75	88	91	92	89	78	74	160-6T/6-30	71	86	95	97	94	88	80	76
125-6T/9-10	57	67	82	86	85	84	73	69	160-6T/6-40	72	87	96	98	95	89	81	77
125-6T/9-15	59	69	84	88	87	86	75	71	160-6T/6-50	74	89	98	100	97	91	83	79
125-6T/9-20	62	72	87	91	90	89	78	74	160-6T/9-15	67	85	94	93	92	88	79	74
125-6T/9-25	64	74	89	93	92	91	80	76	160-6T/9-20	68	86	95	94	93	89	80	75
125-6T/9-30	66	76	91	95	94	93	82	78	160-6T/9-25	69	87	96	95	94	90	81	76
125-8T/6-3	53	61	73	78	77	72	61	57	160-6T/9-30	70	88	97	96	95	91	82	77
125-8T/6-4	54	62	74	79	78	73	62	58	160-6T/9-40	71	89	98	97	96	92	83	78
125-8T/6-5.5	56	64	76	81	80	75	64	60	160-6T/9-50	72	90	99	98	97	93	84	79
125-8T/6-7.5	58	66	78	83	82	77	66	62	160-6T/9-60	72	90	99	98	97	93	84	79
125-8T/6-10	59	67	79	84	83	78	67	63	160-6T/9-75	73	91	100	99	98	94	85	80
125-8T/9-4	51	62	72	78	79	74	63	59	160-6T/9-100	75	93	102	101	100	96	87	82
125-8T/9-5.5	53	64	74	80	81	76	65	61	160-8T/6-4	60	75	84	86	83	77	69	65
125-8T/9-7.5	56	67	77	83	84	79	68	64	160-8T/6-5.5	61	76	85	87	84	78	70	66
125-8T/9-10	58	69	79	85	86	81	70	66	160-8T/6-7.5	62	77	86	88	85	79	71	67
125-8T/9-15	59	70	80	86	87	82	71	67	160-8T/6-10	63	78	87	89	86	80	72	68
140-6T/6-5.5	66	81	90	92	89	83	75	71	160-8T/6-15	65	80	89	91	88	82	74	70
140-6T/6-7.5	67	82	91	93	90	84	76	72	160-8T/6-20	66	81	90	92	89	83	75	71
140-6T/6-10	68	83	92	94	91	85	77	73	160-8T/6-25	68	83	92	94	91	85	77	73
140-6T/6-15	69	84	93	95	92	86	78	74	160-8T/9-7.5	60	78	87	86	85	81	72	67
140-6T/6-20	71	86	95	97	94	88	80	76	160-8T/9-10	62	80	89	88	87	83	74	69
140-6T/6-25	72	87	96	98	95	89	81	77	160-8T/9-15	63	81	90	89	88	84	75	70
140-6T/6-30	73	88	97	99	96	90	82	78	160-8T/9-20	64	82	91	90	89	85	76	71
140-6T/9-10	66	84	93	92	91	87	78	73	160-8T/9-25	65	83	92	91	90	86	77	72
140-6T/9-15	67	85	94	93	92	88	79	74	160-8T/9-30	66	84	93	92	91	87	78	73
140-6T/9-20	69	87	96	95	94	90	81	76	160-8T/9-40	68	86	95	94	93	89	80	75

Afmetingen:

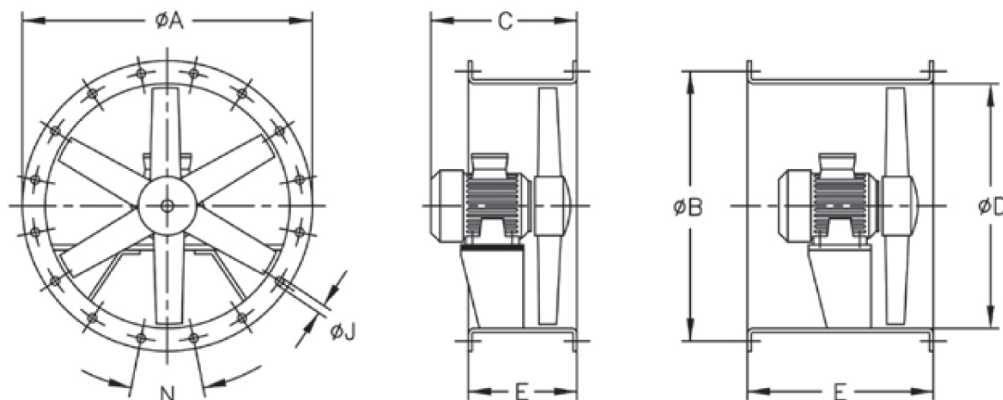

Model	ØA	ØB	C (Consult motor construction size)							ØD	E*		ØJ	N
			132	160	180	200	225	250	280		Short (STD)	long		
HGT-125	1365	1320	586	-	-	-	-	-	-	1250	500	700	15	20x18°
HGT-125	1365	1320	-	700	-	-	-	-	-	1250	500	700	15	20x18°
HGT-125	1365	1320	-	-	765	825	-	-	-	1250	700	900	15	20x18°
HGT-125	1365	1320	-	-	-	-	910	-	-	1250	700	1000	15	20x18°
HGT-125	1365	1320	-	-	-	-	-	985	-	1250	700	1000	15	20x18°
HGT-125	1365	1320	-	-	-	-	-	-	1190	1250	700	1200	15	20x18°
HGT-140	1515	1470	586	-	-	-	-	-	-	1400	400	650	15	20x18°
HGT-140	1515	1470	-	700	-	-	-	-	-	1400	450	700	15	20x18°
HGT-140	1515	1470	-	-	765	825	-	-	-	1400	550	900	15	20x18°
HGT-140	1515	1470	-	-	-	-	910	-	-	1400	550	1000	15	20x18°
HGT-140	1515	1470	-	-	-	-	-	985	-	1400	600	1000	15	20x18°
HGT-160	1735	1680	586	-	-	-	-	-	-	1600	400	650	19	24x15°
HGT-160	1735	1680	-	700	-	-	-	-	-	1600	450	700	19	24x15°
HGT-160	1735	1680	-	-	765	825	-	-	-	1600	550	900	19	24x15°
HGT-160	1735	1680	-	-	-	-	910	-	-	1600	550	1000	19	24x15°
HGT-160	1735	1680	-	-	-	-	-	985	-	1600	600	1000	19	24x15°
HGT-160	1735	1680	-	-	-	-	-	-	1190	1600	700	1200	19	24x15°

* Standard version supplied with short casing. Long casing with inspection hatch available on request.

Motor construction sizes depending on power

Poles	r/min	HP	3	4	5.5	7.5	10	15	20	25	30	40	50	60	75	100
4T	1500	-	-	-	-	-	132	160	160	180	180	200	225	225	250	280
6T	1000	-	-	132	132	132	160	160	180	200	200	225	250	280	280	280
8T	750	-	132	132	160	160	160	180	200	225	225	250	-	-	-	-

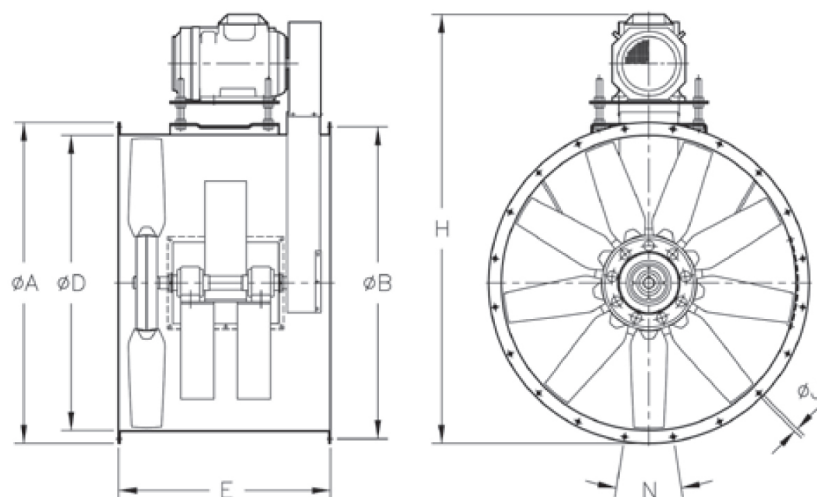
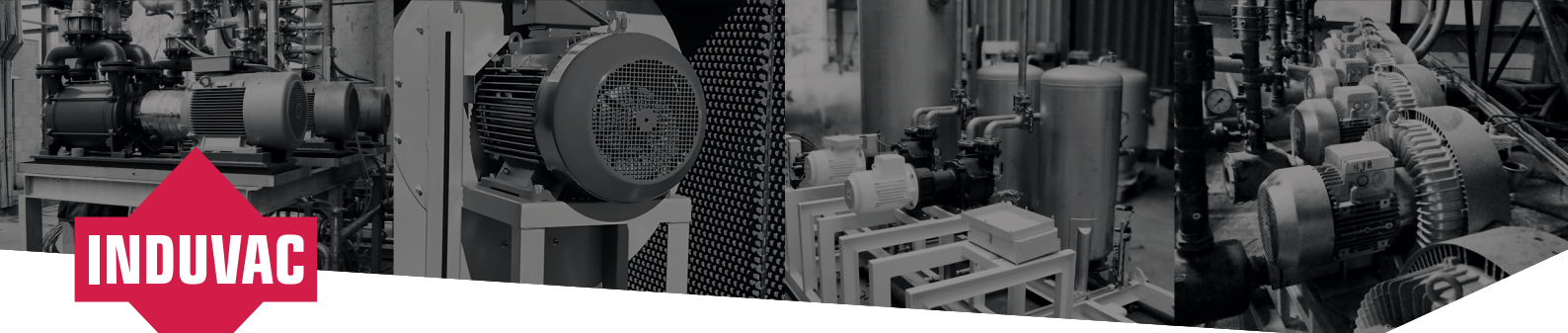

Model	ØA	ØB	ØD	E	H (Consult motor construction size)						ØJ	N	
					132	160	180	200	225	250	280		
HGT-X 125	1365	1320	1250	900	1743	1815	1850	-	-	-	-	15	20x18°
HGT-X 125	1365	1320	1250	960	-	-	-	1930	1995	-	-	15	20x18°
HGT-X 125	1365	1320	1250	1100	-	-	-	-	-	2060	-	15	20x18°
HGT-X 125	1365	1320	1250	1100	-	-	-	-	-	-	2090	15	20x18°

Motor construction sizes depending on power

Poles	r/min	HP	3	4	5.5	7.5	10	15	20	25	30	40	50	60	75	100
4T	1500	-	-	-	-	-	132	160	160	180	180	200	225	225	250	280
6T	1000	-	132	132	132	160	160	180	200	200	225	225	250	280	280	280
8T	750	-	132	132	160	160	160	180	200	225	225	250	-	-	-	-

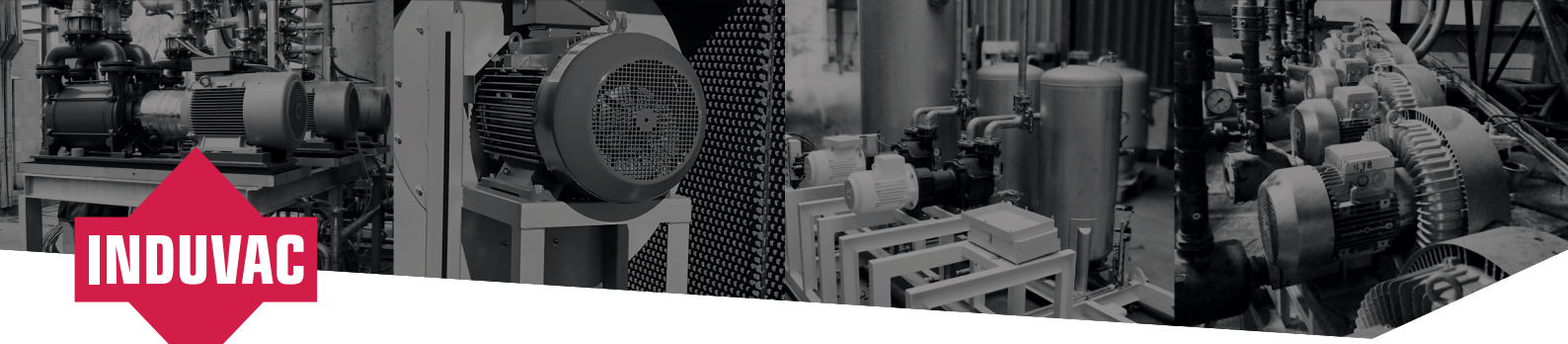
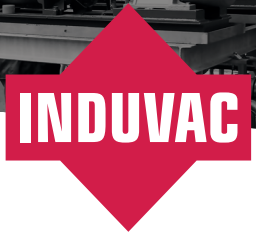

Curves:

Impeller diameter (cm): 125

Number of poles: 4

Number of blades: 6

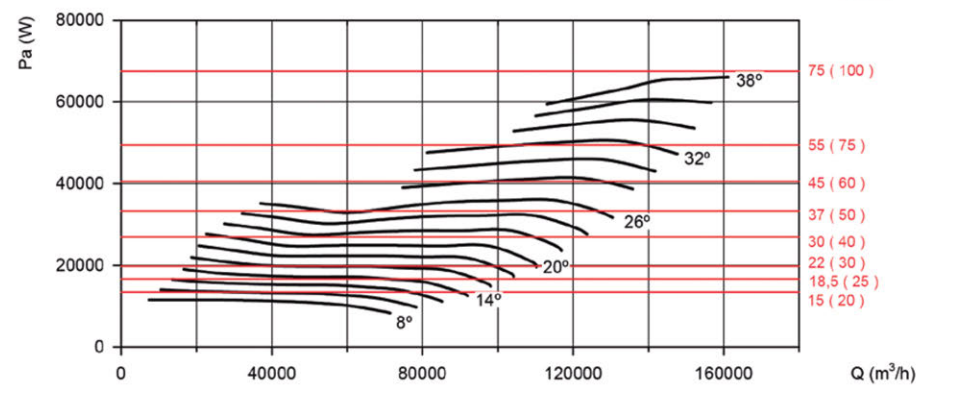
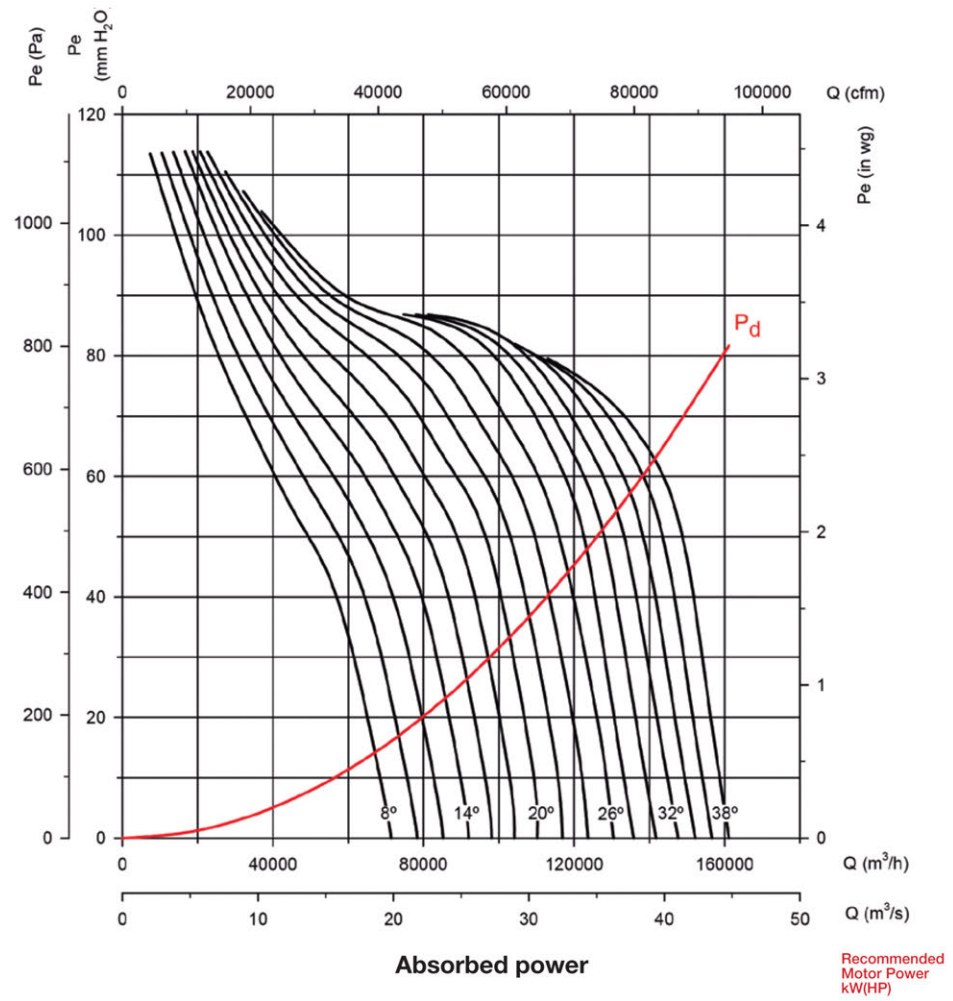

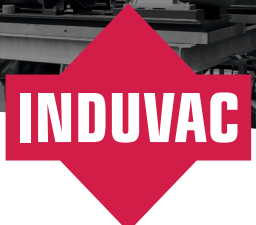

Impeller diameter (cm): 125

Number of poles: 4

Number of blades: 9

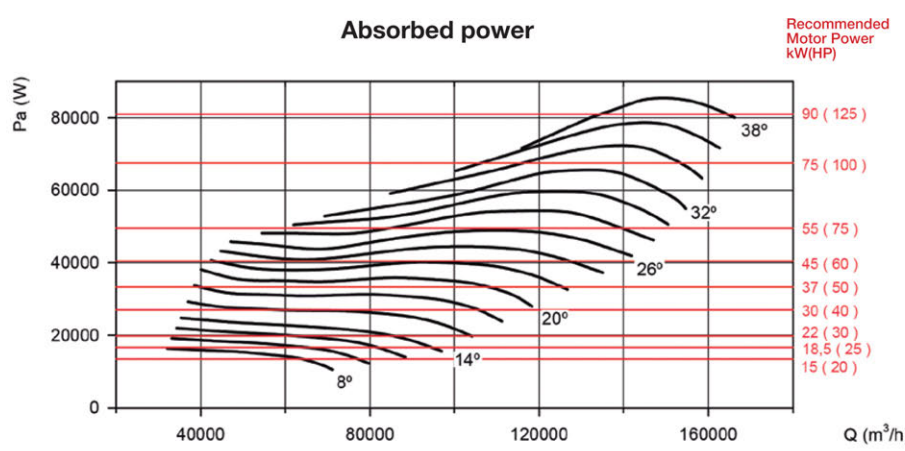
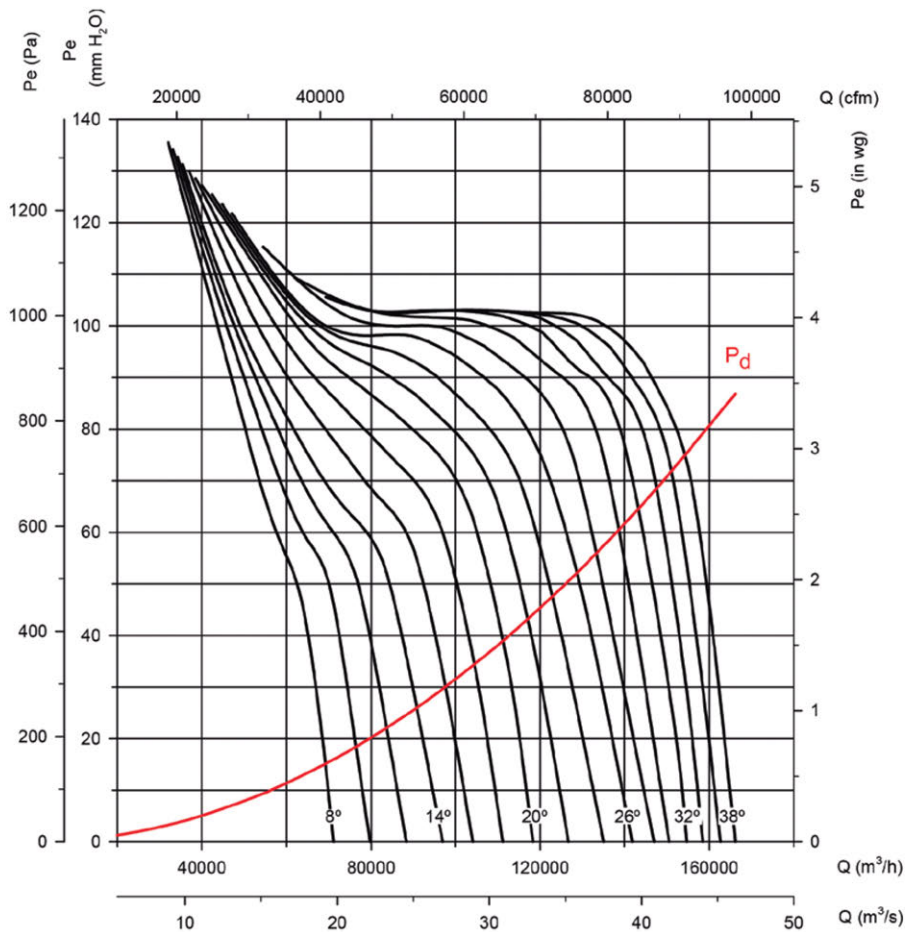

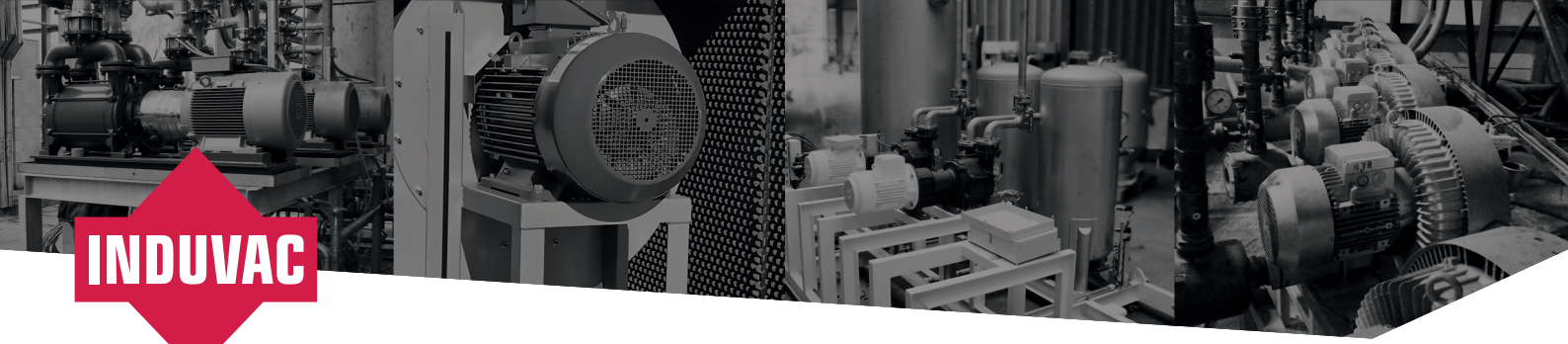

Impeller diameter (cm): 125

Number of poles: 6

Number of blades: 6

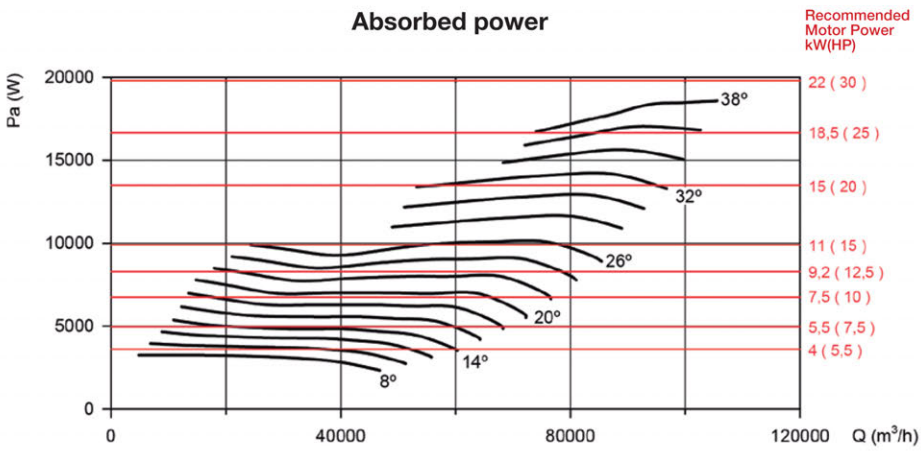
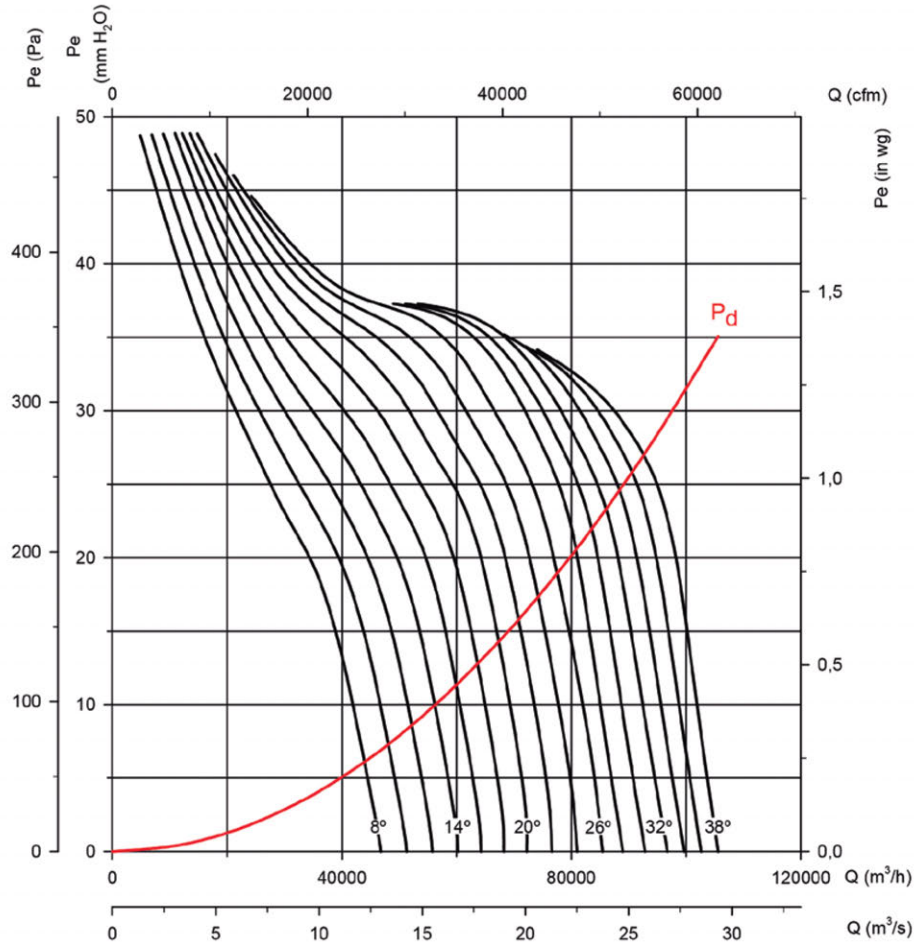

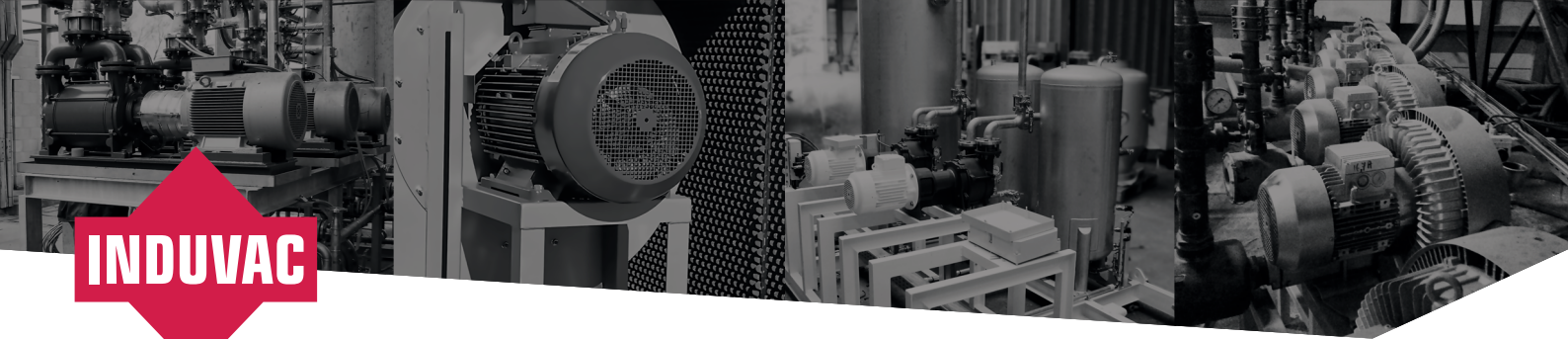

INDUVAC

Impeller diameter (cm): 125

Number of poles: 6

Number of blades: 9

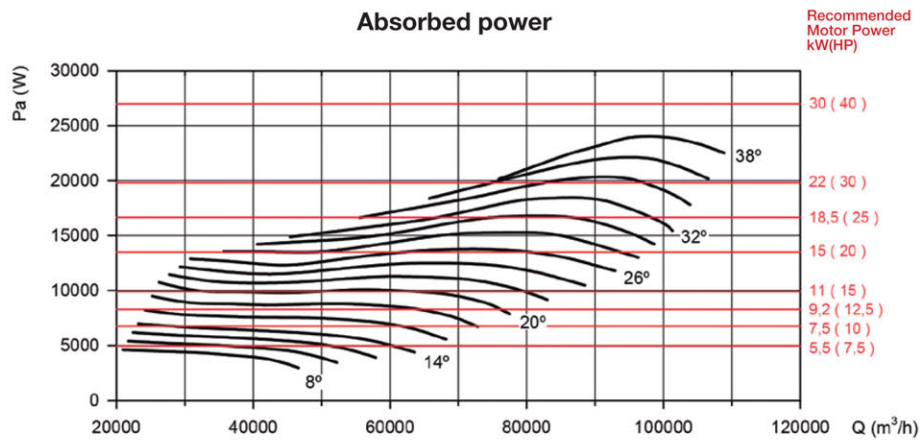
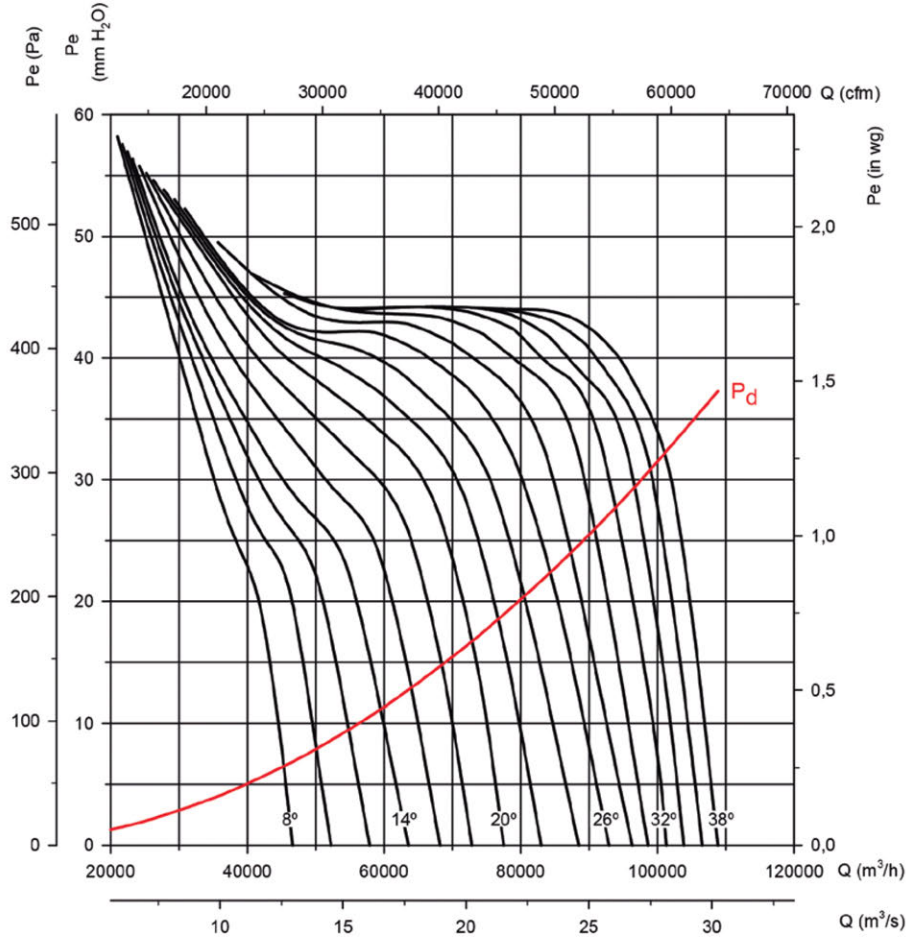



Impeller diameter (cm): 125

Number of poles: 8

Number of blades: 6

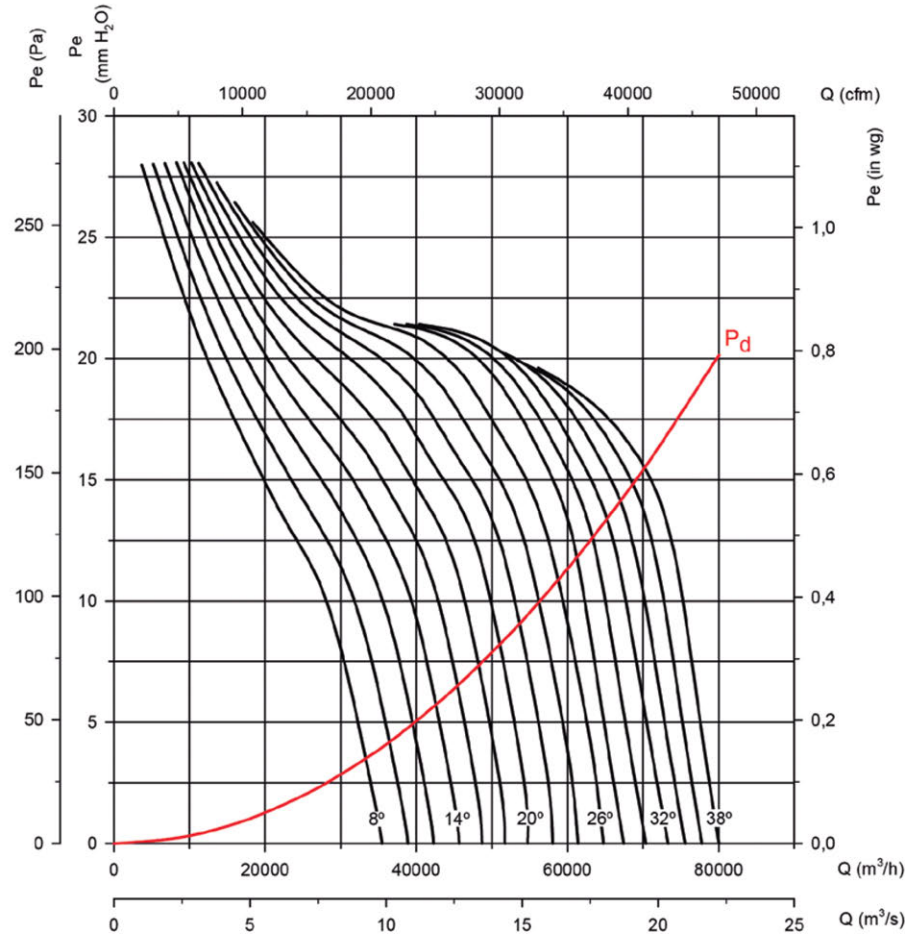

Absorbed power

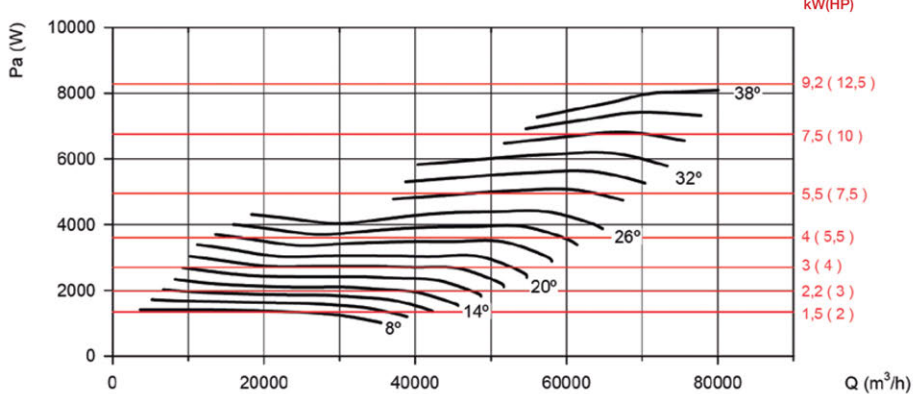



Impeller diameter (cm): 125

Number of poles: 8

Number of blades: 9

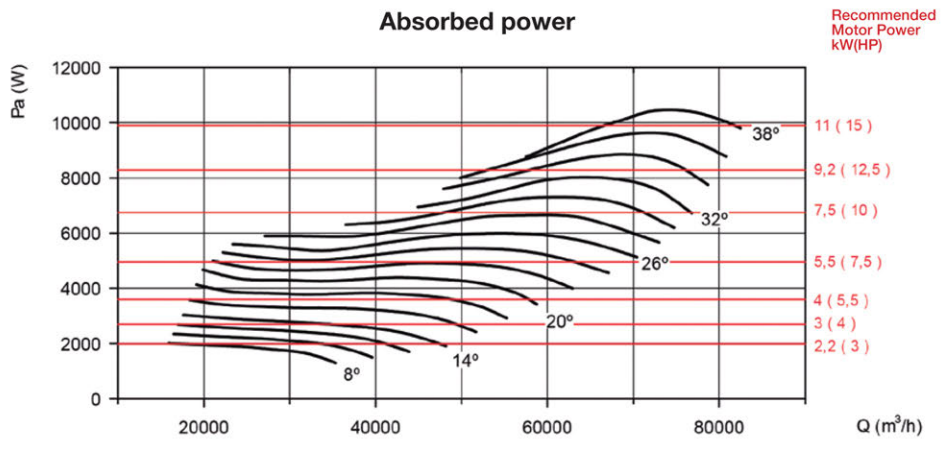
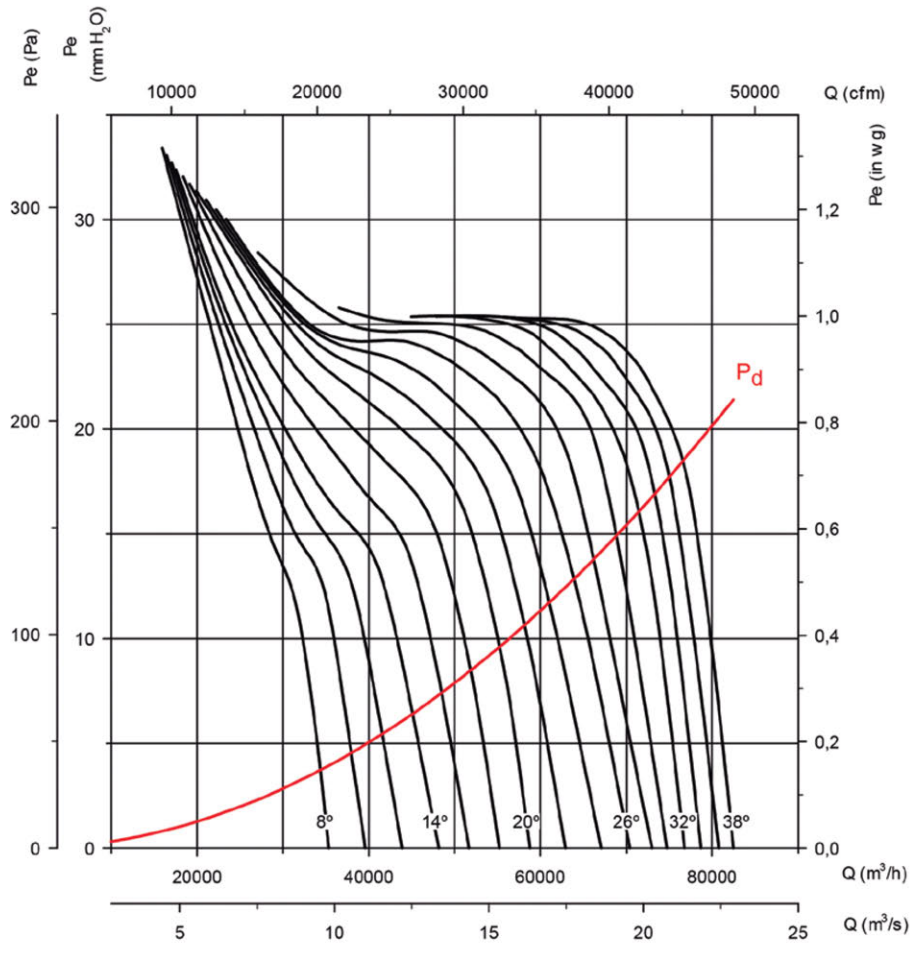

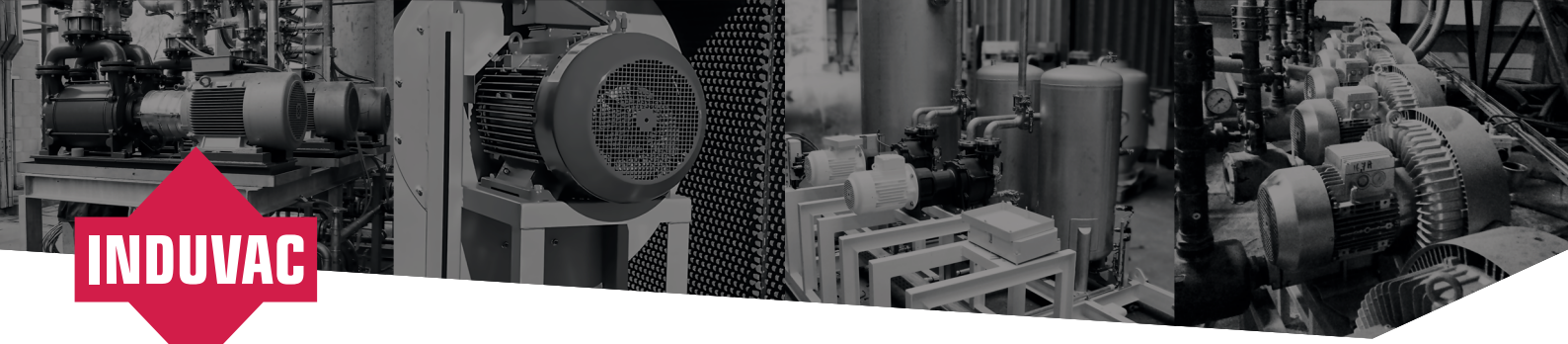

Impeller diameter (cm): 140

Number of poles: 6

Number of blades: 6

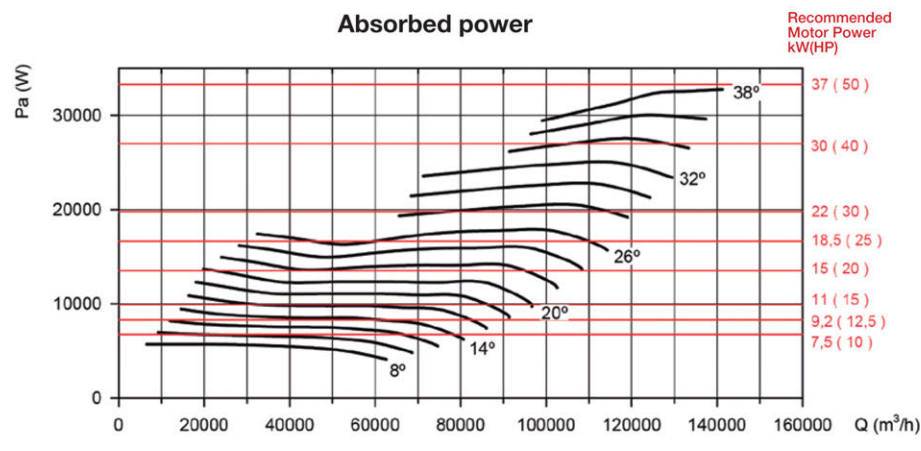
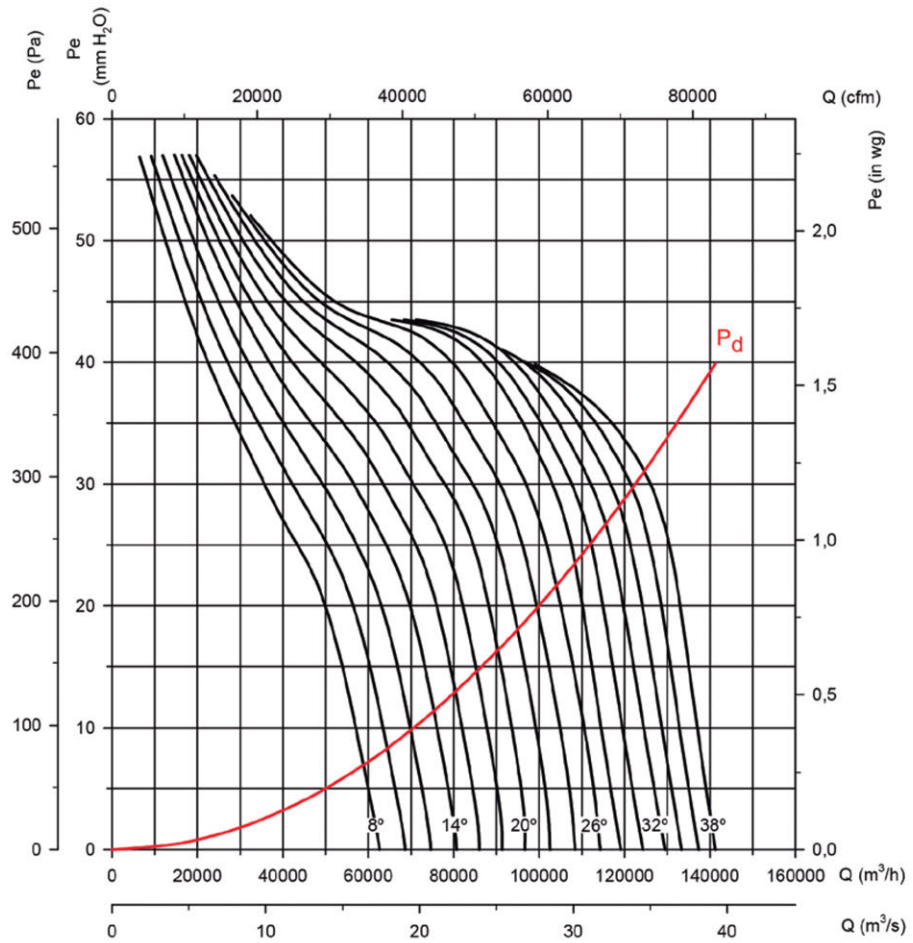

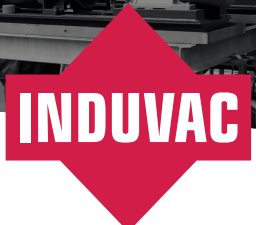

Impeller diameter (cm): 140

Number of poles: 6

Number of blades: 9

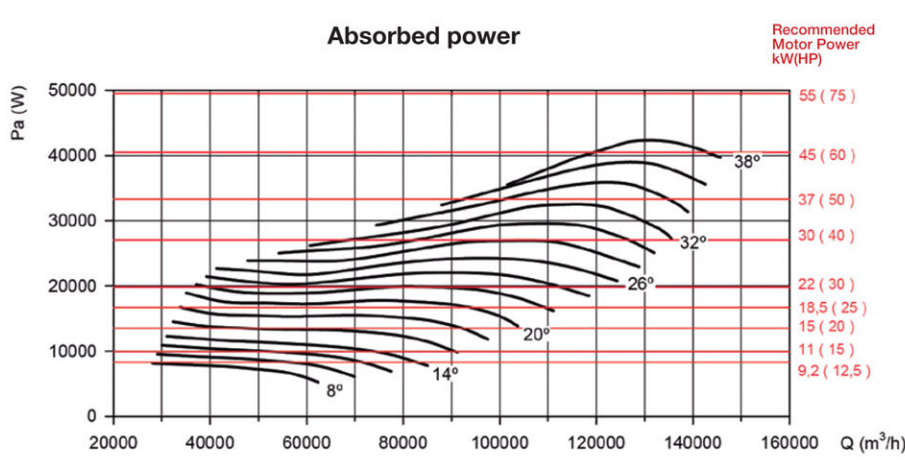
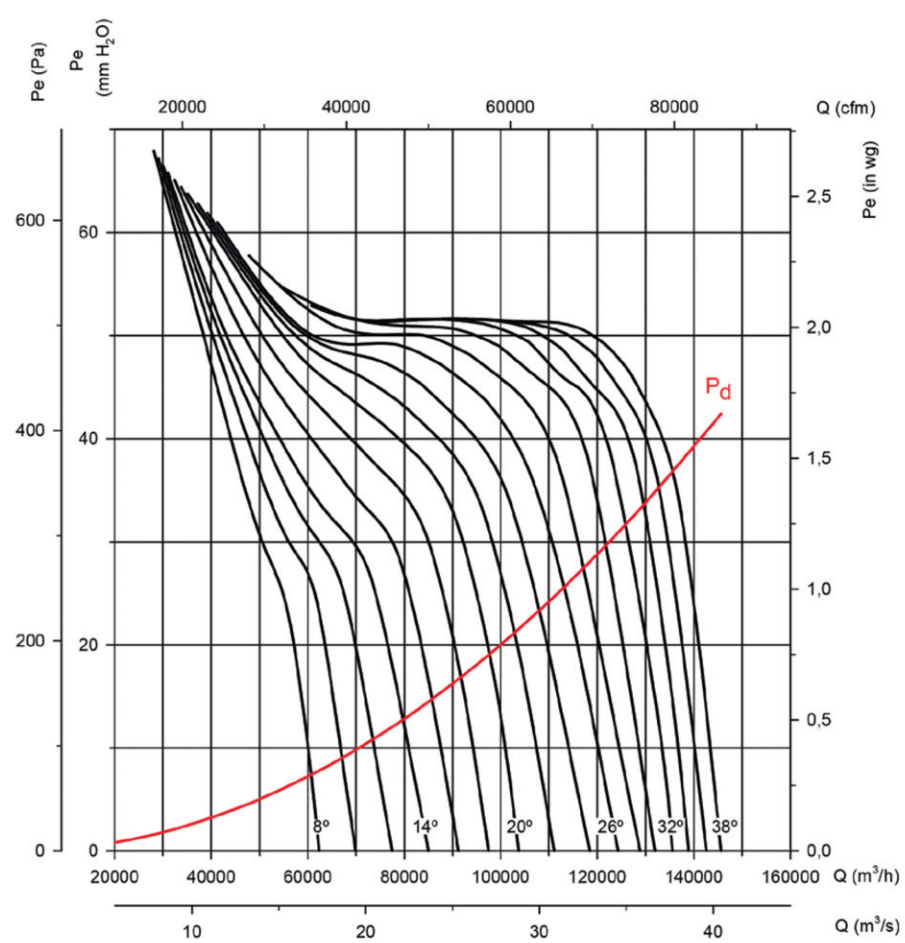

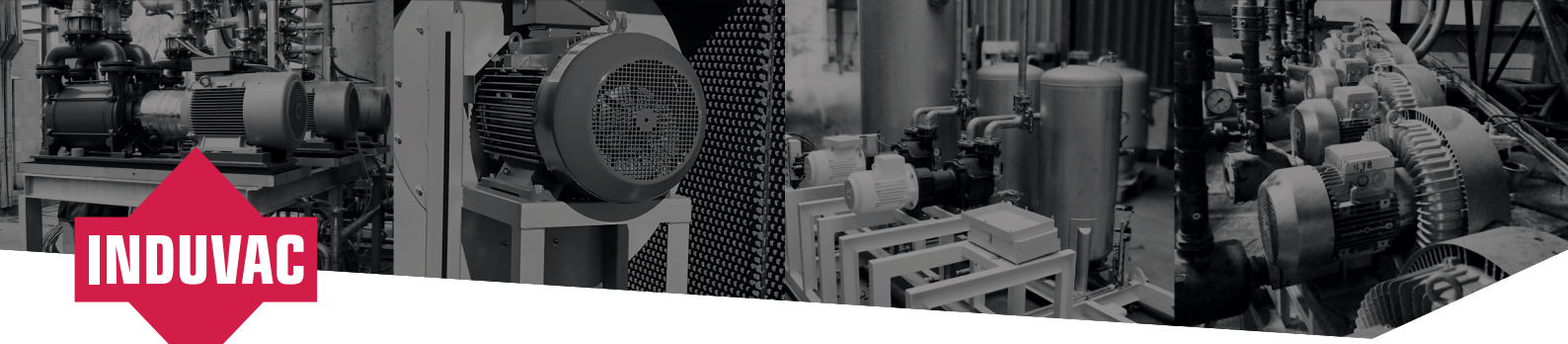

Impeller diameter (cm): 140

Number of poles: 8

Number of blades: 6

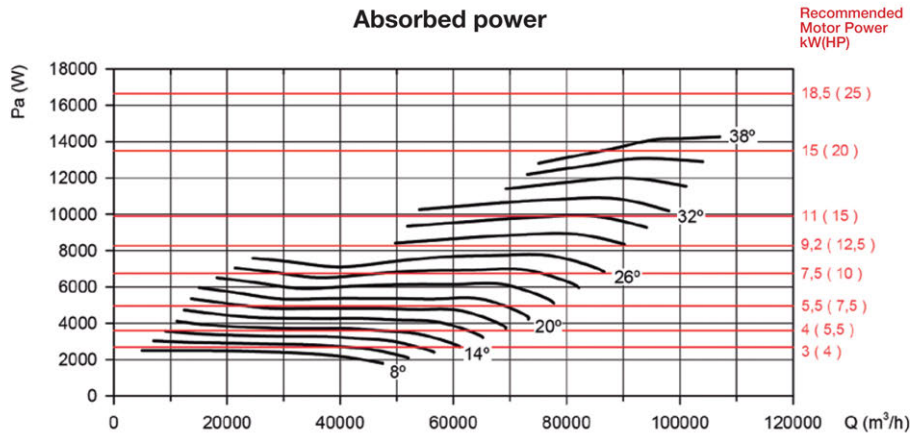
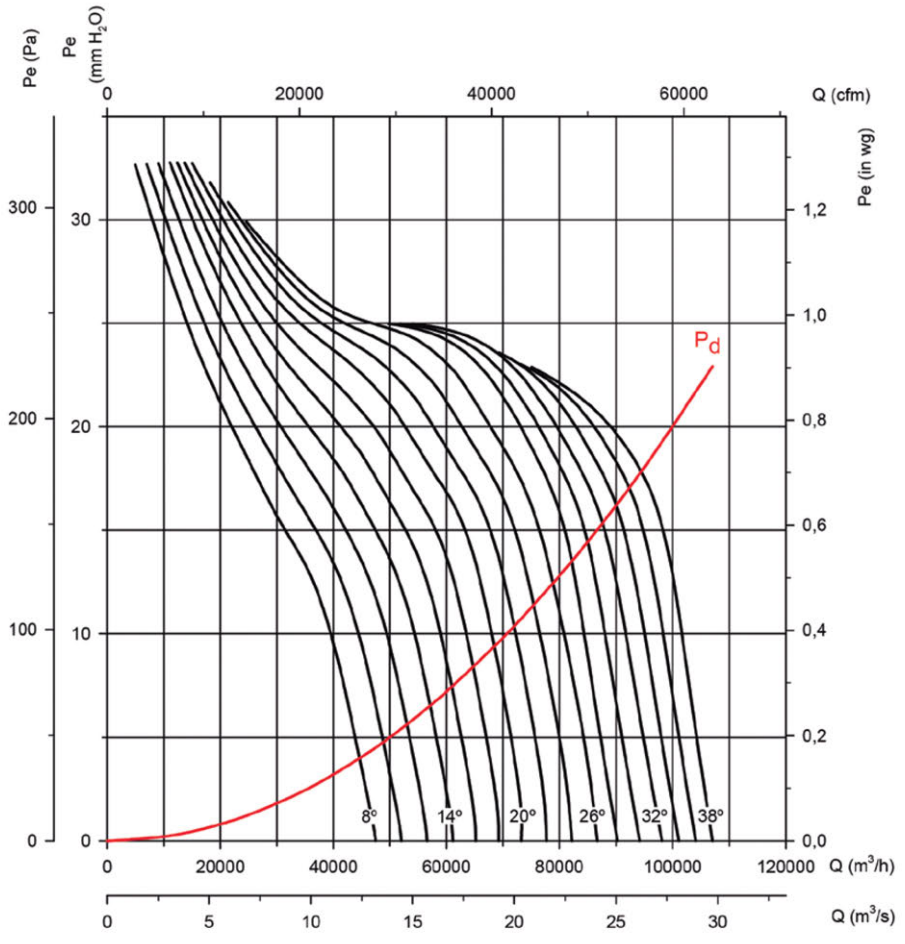

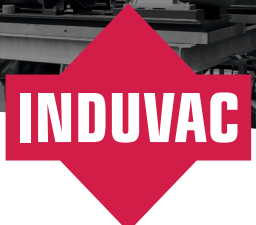

Impeller diameter (cm): 140

Number of poles: 8

Number of blades: 9

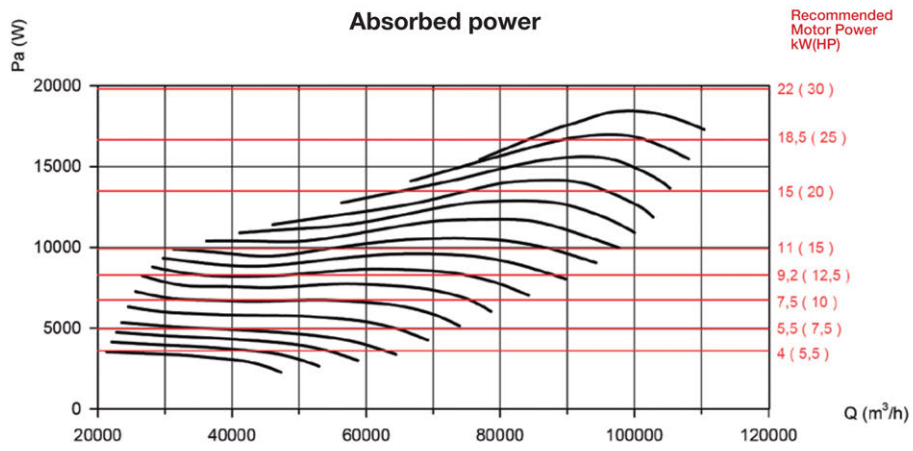
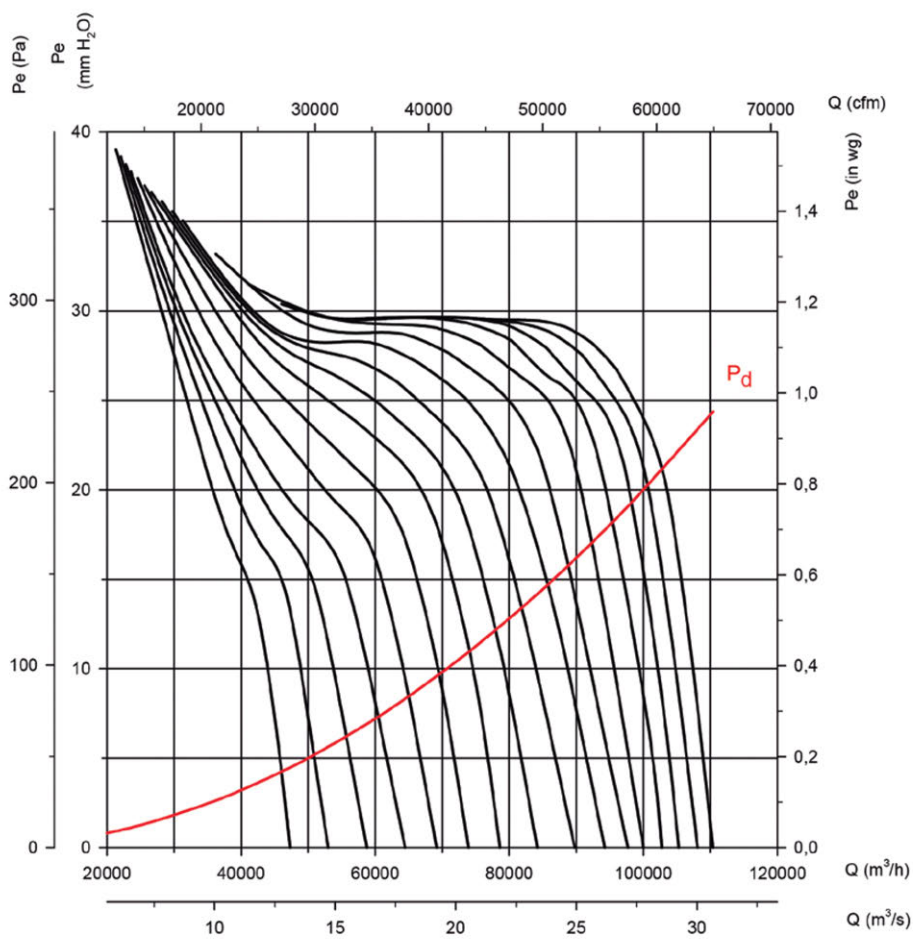

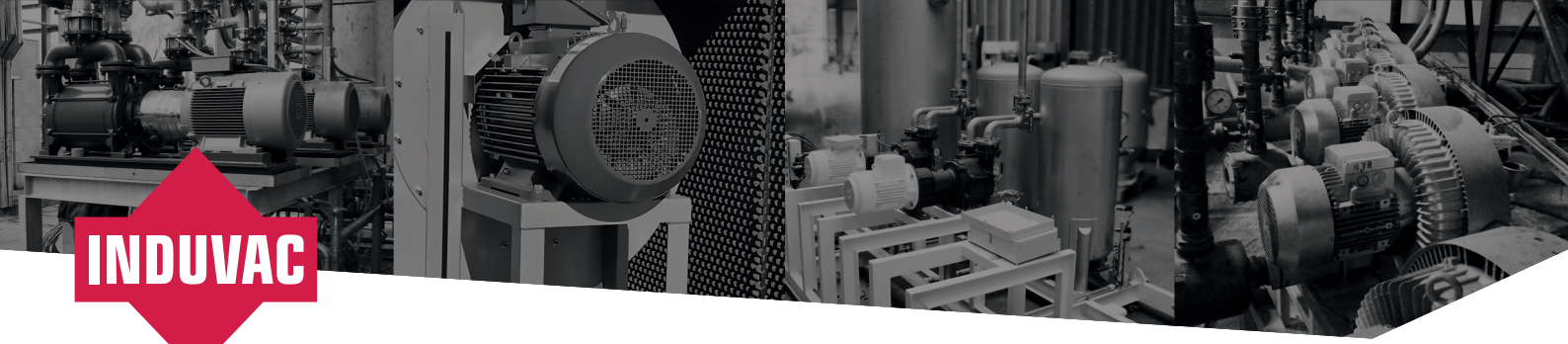

Impeller diameter (cm): 160

Number of poles: 6

Number of blades: 6

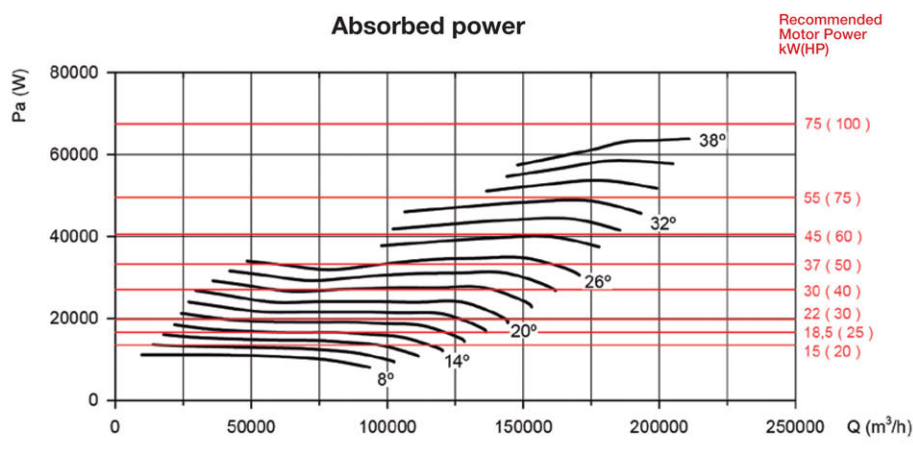
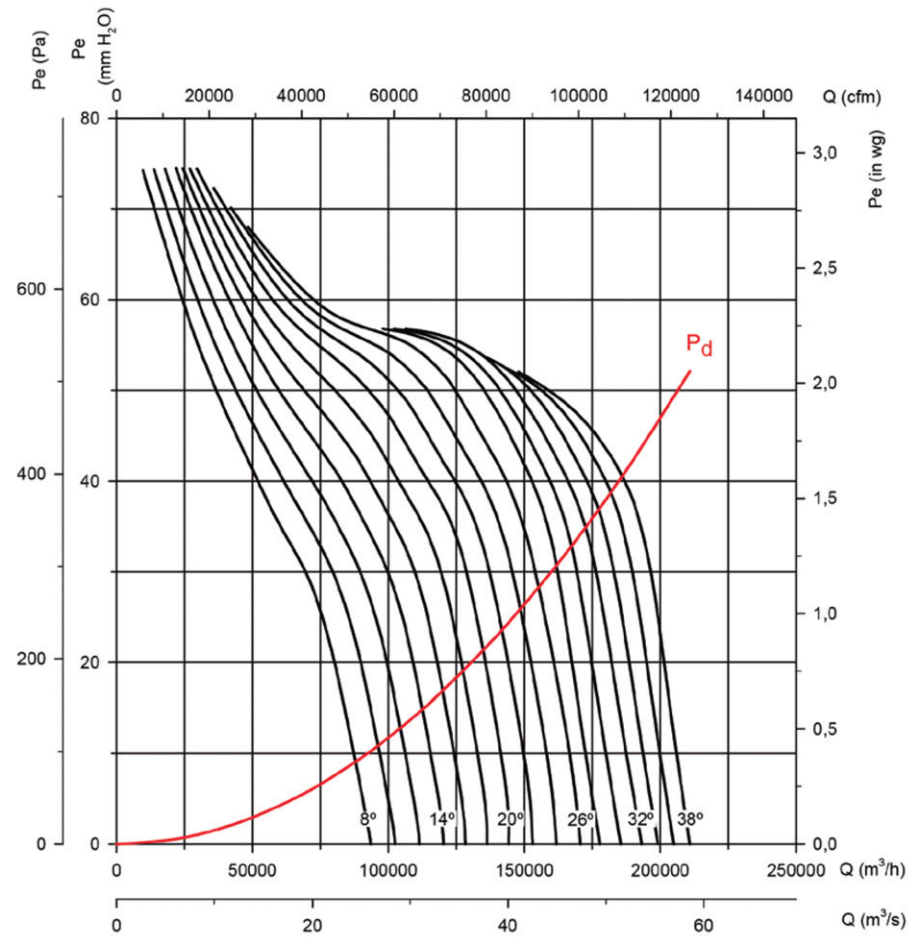



Impeller diameter (cm): 160

Number of poles: 6

Number of blades: 9

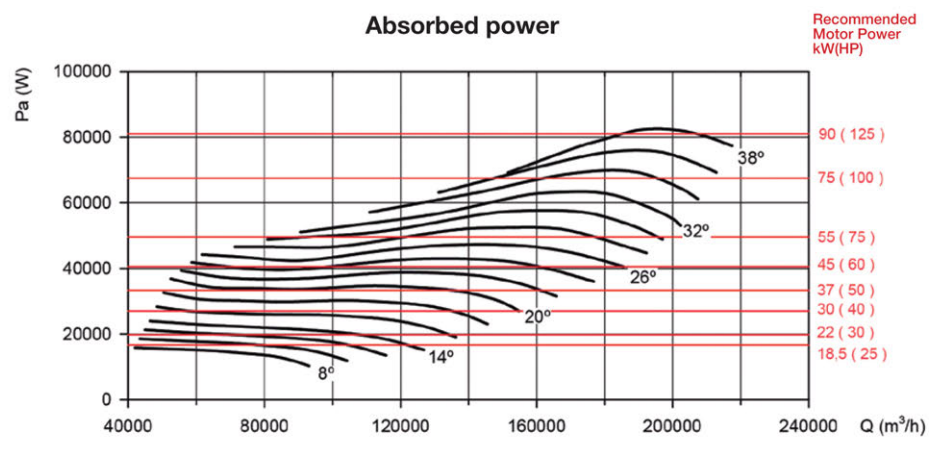
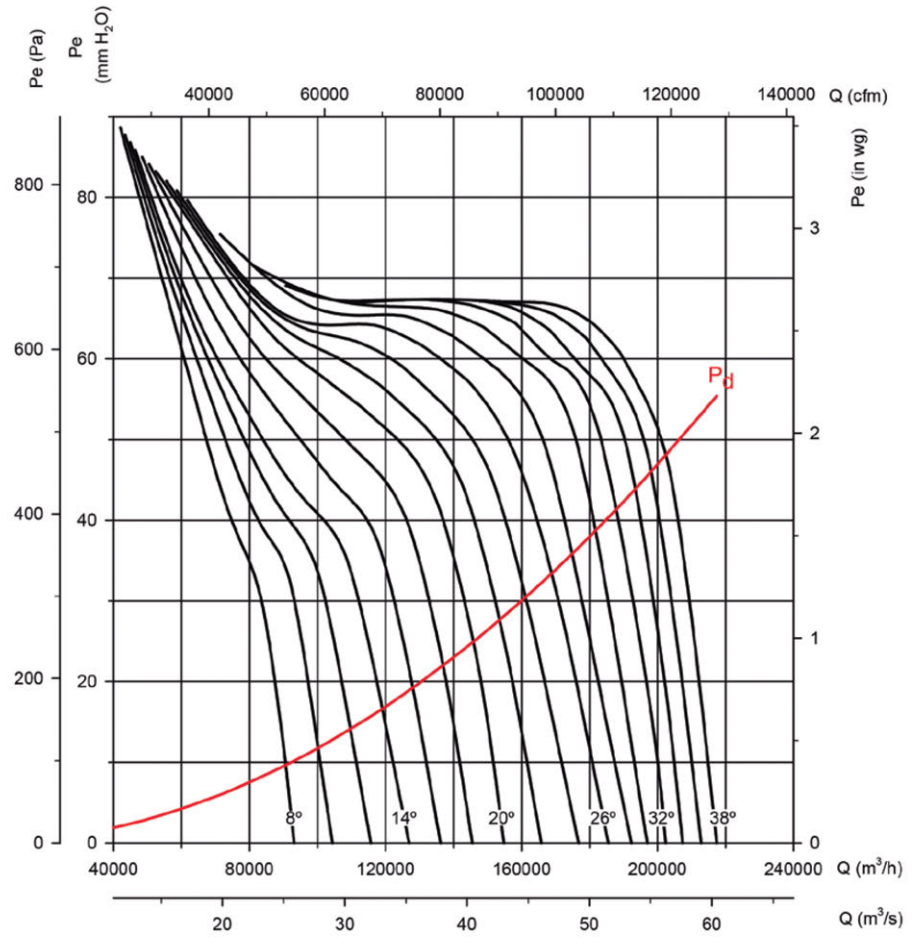



Impeller diameter (cm): 160

Number of poles: 8

Number of blades: 6

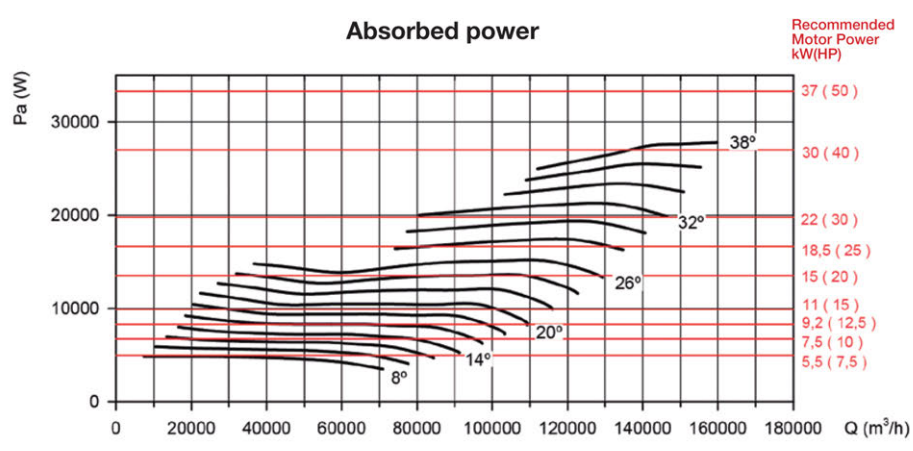
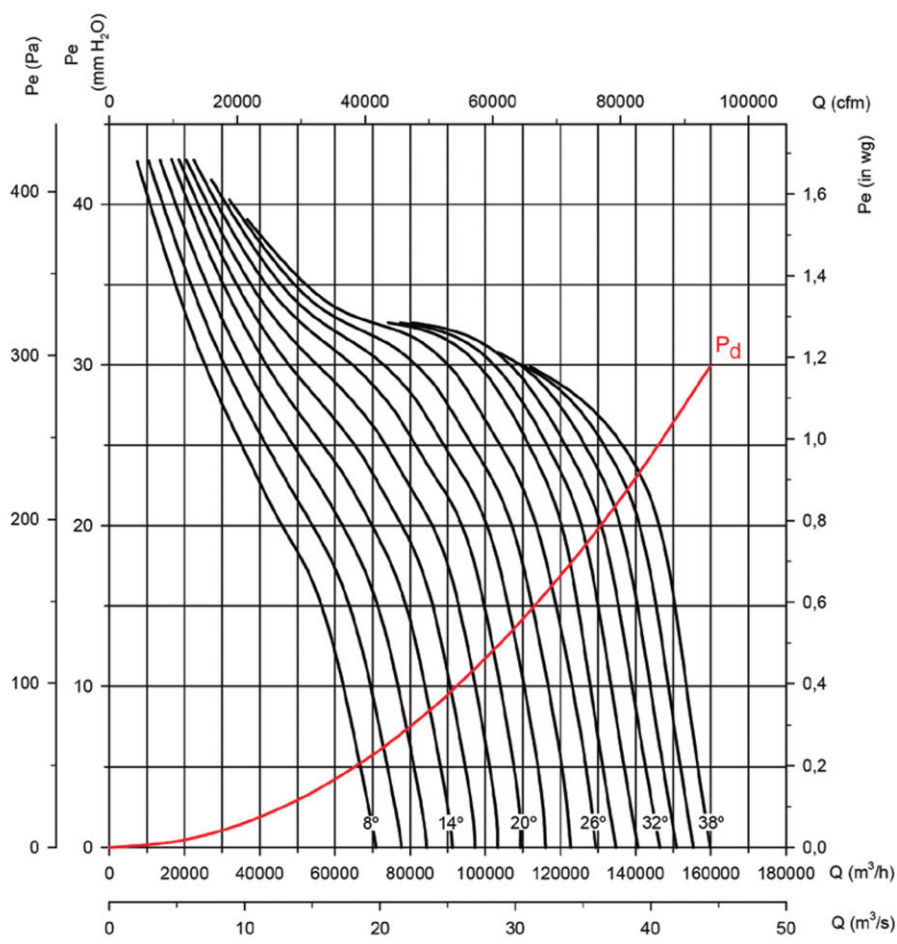



Impeller diameter (cm): 160

Number of poles: 8

Number of blades: 9

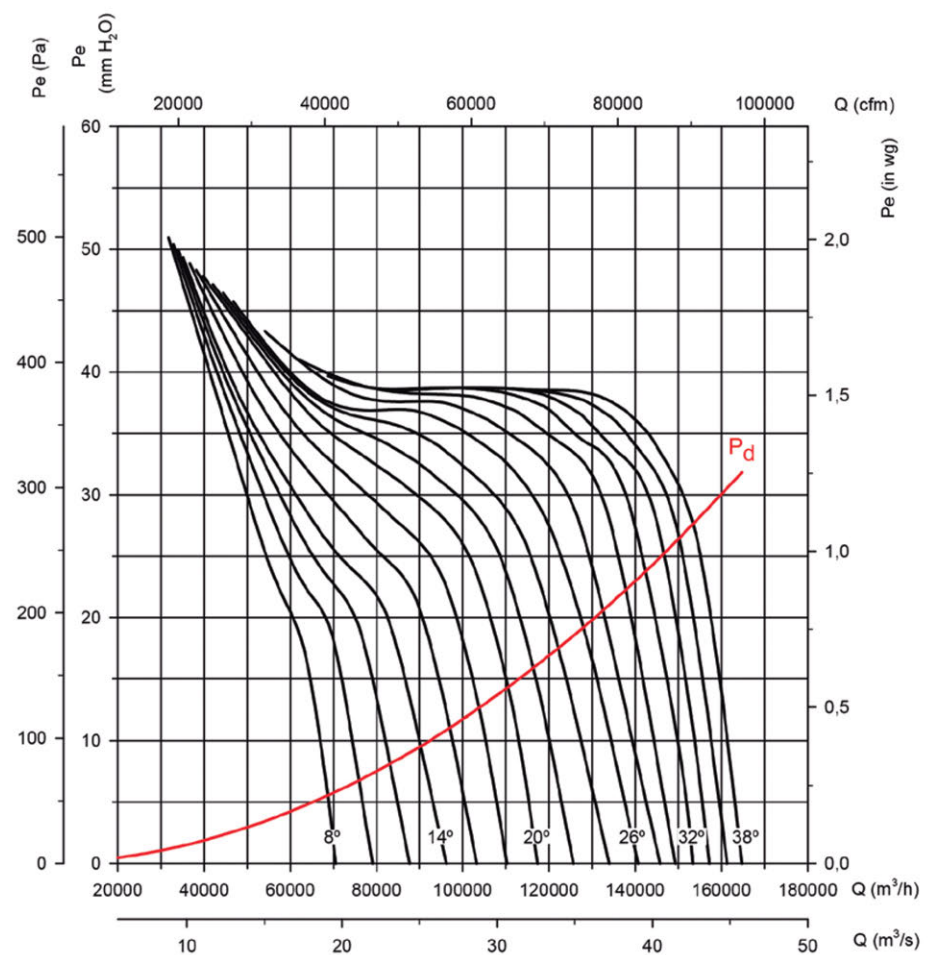

Absorbed power

Recommended Motor Power kW(HP)

